

DIAMOND

Fiber Optic Components

CABLE ASSEMBLIES AND ADAPTERS

DIAMOND supplies high-quality solutions for polarization-maintaining (PM) and polarizing (PZ) fiber-optical interfaces providing optimum control of the signal polarization state.

The PM+ connector family is designed to achieve the highest possible polarization extinction ratio (PER) while maintaining outstanding insertion loss (IL) and return loss (RL) values. These optical values are ensured thanks to the selected connector variants that possess excellent mechanical properties and few angle errors.

APPLICATION FIELDS

Thanks to very high PER values, Diamond's PM+ connector family opens up whole new possibilities in the development and design of new measuring and diagnostics devices.

- ▶ Biomedicine
- ▶ Spectroscopy
- ▶ Meteorology
- ▶ Sensor technology

FEATURES AND BENEFITS

- ▶ Processes for active polarization orientation (APO)
- ▶ Best optical performance
- ▶ Homologated fiber types for wavelengths ranging from 405 to 1625 nm
- ▶ Specialized, homologation-ready fiber types
- ▶ Customer-specific configurations

AVAILABLE AS

- ▶ Configuration: Patchcord, pigtail
- ▶ Connector type: E-2000™, DMI, Mini AVIM™
- ▶ Ferrule interface: APC, PC
- ▶ Fiber type: Diamond homologated PANDA fibers
- ▶ Fiber protection: Loose-tube construction

QUALITY & STANDARDS

All Diamond products meet the international quality standards governing polarization-maintaining optical fibers and connectors. This includes the Standards IEC 61755-3-7/8 (PC and APC 2.5-mm zirconium dioxide (ZrO₂) with titanium ferrules) for 1310- and 1550-nm wavelengths.

The qualification testing program of the E-2000™, DMI and Mini AVIM™ APC PM+ connectors is specified in accordance with the guidelines stipulated in IEC 61753-1, which defines the minimum requirements and grades of severity that a single-mode connector must meet.

PM+

(Polarization-maintaining optical fiber)
High polarization extinction ratios (PER)

E-2000™ PM+ / DMI PM+ /
Micro AVIM™ PM+ / Mini AVIM™ PM+

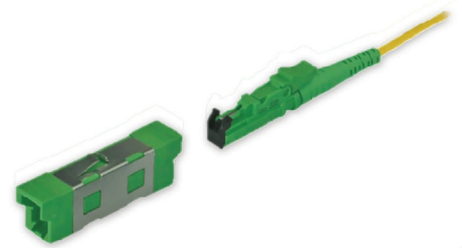

E-2000™ PM+ connector

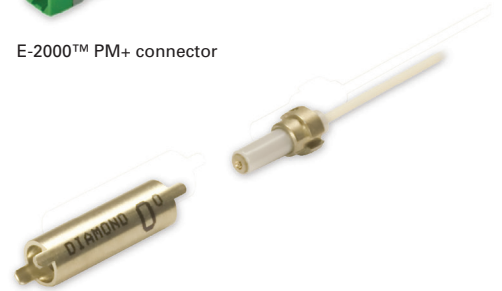

DMI PM+ connector

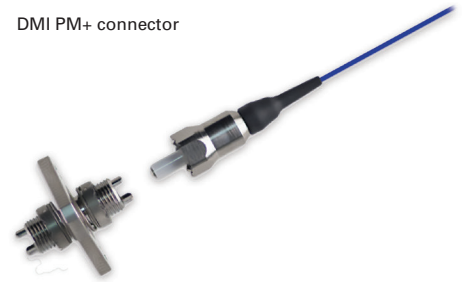

Mini AVIM™ PM+ connector

PM+

PM+ CONNECTOR SPECIFICATIONS

WAVELENGTH (nm)	IL (dB)		PER (dB)		RL (db)	
	Typ.	Max.	Typ.	Min.	PC 0°	APC 8°
1625 - 1550 - 1310	0.15	0.30	30	27	50*	70*
1060 - 980	0.20	0.40	30	26	50	60*
830 - 780	0.25	0.50	28	25	40	60**
680 - 638	0.30	0.60	28	25	35	60**
532 - 460	0.40	0.80	27	23	35	60**
405	0.60	1.20	23	21	35	60**
TEST CONDITIONS	IEC 61300-3-4 Method B		Diamond method, similar to IEC 61300-3-40, -3-24 Low coherence		IEC 61300-3-6 *OLCR method **OCWR method, limited by test conditions	
Lifetime	500 mate/demate cycles					

- The indicated values apply at ambient temperature, and are based on the optically high-quality fibers homologated by Diamond.
- Performance is based on the indicated connector types. Other mechanical interconnections may lead to deviations in optical performance.
- The maximum angle error of the PM+ connector types is 2°.
- Optical values specified at room temperature, and based upon high-quality Panda fibers (fiber's NA 0.12± 0.02) qualified by Diamond.

ENVIRONMENTAL CONDITIONS

MEASUREMENT / TEST	PARAMETER	METHOD
Temperature change (reliability)	-40°C / +85°C / 1 h dwell / 500 cycles	IEC 61300-2-22
Dry heat (reliability)	+85°C / 2'000 h	IEC 61300-2-18
Damp heat, cyclic (reliability)	+25°C / +55°C / 95% r.h. / 100 cycles	IEC 61300-2-46
Connection cycles (mating durability)	-40°C / 96 h	IEC 61300-2-17

MECHANICAL CONDITIONS

MEASUREMENT / TEST	PARAMETER	METHOD
Cable tensile stress	100 N / 2 min	IEC 61300-2-4
Cable torsion	15 N / ±180° / 25 cycles	IEC 61300-2-5
Vibration, sinusoidal	10 Hz - 55 Hz / 1.5 mm / 30 min	IEC 61300-2-1
Connection cycles (mating durability)	500 cycles	IEC 61300-2-2

CONNECTOR TYPES AND DIMENSIONS

E-2000™-PM

Available types: **E-2000™ PM - PC and APC**
 Ferrule material: Zirconia/metal insert
 External parts: Plastic

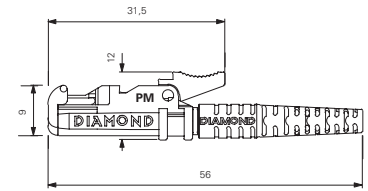

LSA (DIN)-PM

Available types: **DIN PM - PC and APC**
 Ferrule material: Zirconia/metal insert
 External parts: Copper-nickel alloy

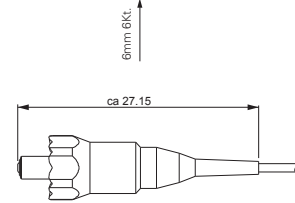

Mini AVIM™-PM

Available types: **Mini AVIM™ PM - PC and APC**
 Material: According to part list

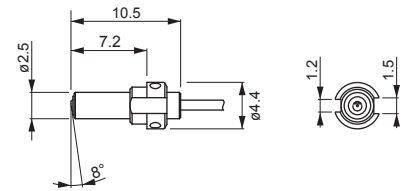

DMI-PM

Available types: **DMI PM - PC and APC**
 Ferrule material: Zirconia/metal insert
 External parts: Metal

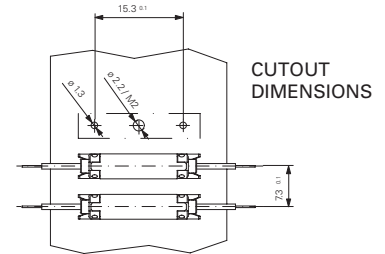

NOTE Standard colors for connectors and mating adapters made from plastic: Blue for PC and green for APC.

Mini AVIM™ PM mating adapter

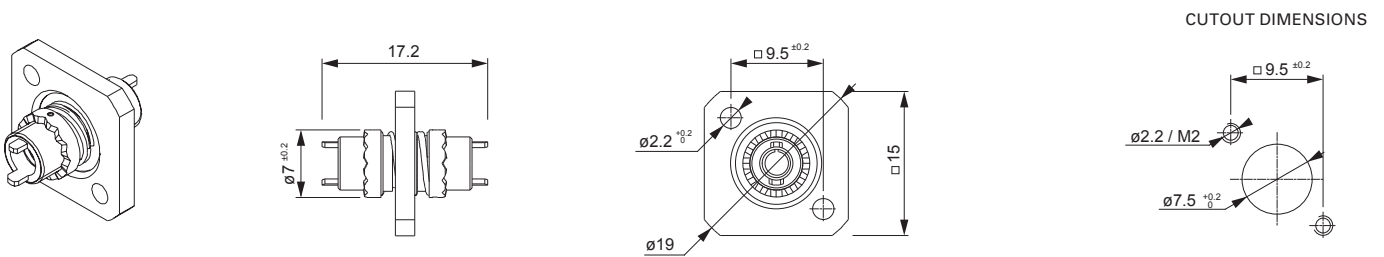

DMI PM mating adapter

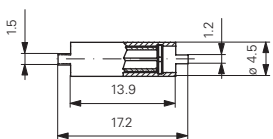

DMI PM Clip mating adapter clip

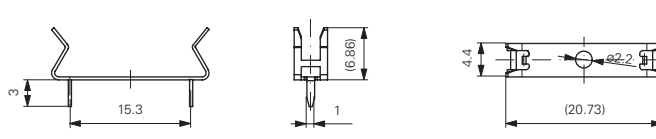

NOTE You'll find technical information on the connectors HE-2000, MIL-83526 DM, MIL-38999 DM and the DM insert in the standard data sheets of the individual connector types.

ADAPTER TYPES AND DIMENSIONS

E-2000™ Simplex PM mating adapter with screw fixing clip

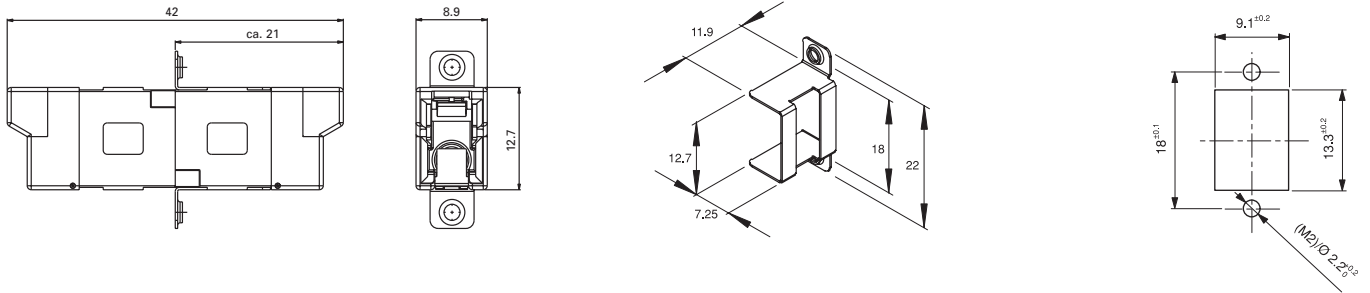

E-2000™ Simplex PM mating adapter with quick fixing clip
(Type A: for higher packaging density within E-2000™ cutout)

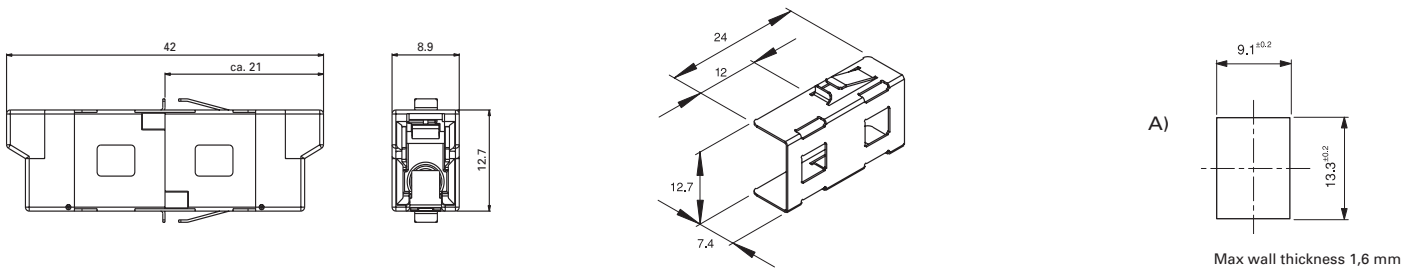

E-2000™ Simplex PM mating adapter with quick fixing clips
(Type B: for excellent stability within SC cutout)

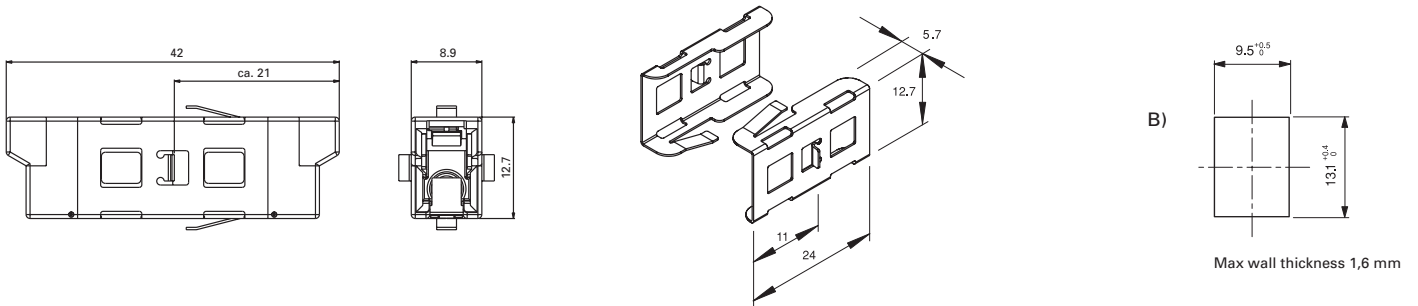

E-2000™ Simplex PM mating adapter with print fixing clip

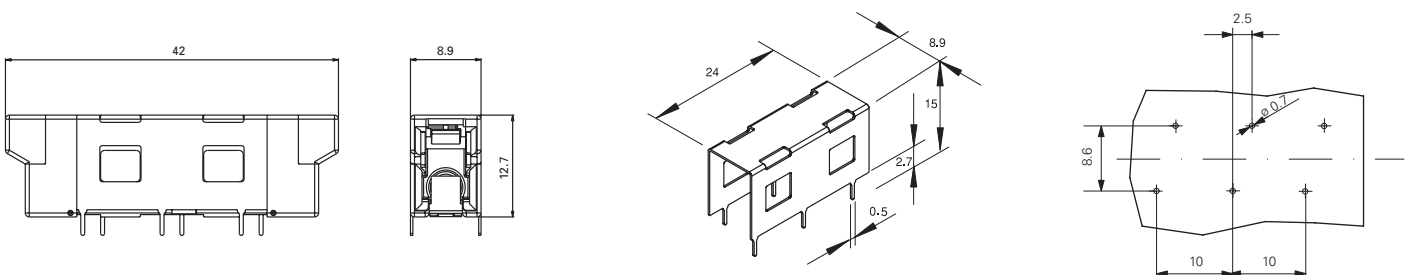

ORDER INFORMATION

Please refer to the part numbers provided in the separate P/N list.
For assemblies or other configurations, please contact your nearest local Diamond representative or fill in the contact form available on the www.diamond-fo.com website.