

DIAMOND

Fiber Optic Components

CABLE ASSEMBLIES AND ADAPTERS

Diamond PS+ connector systems are designed for high power applications up to 16Watts optical power for SM fibers. Diamond Power Solution (PS+) connectors are based on proprietary ferrules terminated with Graded Index Fibers (GIF). GIF expands the beam with a magnification factor of 2.5 to 4.5 performing like a compact GRIN lens. Compared to ball lenses, GIF terminated connector ferrules offer the advantage of superior optical performance in terms of Insertion Loss (IL) and Return Loss (RL). Until now, a high-power ferrule with approximately 25 µm Single mode (SM) expanded beam diameter is used in the DIAMOND PS standard connectors allowing up to 6W long life connectivity. By introducing new manufacturing techniques, we are now able to provide an improved PS+ design offering around 36 µm SM expanded Mode Field Diameter (MFD). This would allow the capability of high-power transmission of up to 16 W within SM optical connectors. This technology is applicable to most connectors interfaces, but due to safety issues Diamond suggests to use it on E-2000® connector with integrated metal protection caps and shutters. All of the features, users have come to expect from the E-2000®, Mini AVIM® and DMI, are available on the PS+ version. Please be aware that there is no intercompatibility between PS and PS+.

For more information about the technical specifications, please refer to the PS Optical Interfaces datasheet available on Diamond website.

FEATURES AND BENEFITS

- ▶ 17x reduced power density
- ▶ Low Insertion loss
- ▶ Ultra high polish for High return loss
- ▶ E-2000® with integrated metal protection caps and Shutters
- ▶ E-2000® with interchangeable colour- and mechanical-coded frames and thumb-latches.
- ▶ DMI: Minimal space requirement, PC board mount capability and excellent vibration resistance
- ▶ Mini AVIM®: titanium construction, lightweight, compact and embeddable

STANDARDS

- ▶ Passed long term test at 16W, 2000h on E-2000® PS+ connector
- ▶ Passed Performance qualification according to *IEC 61753-2-1, cat. U*
- ▶ Passed Reliability qualification according to *IEC 62005-9-2, cat. U*
- ▶ Passed Long term Damp Heat according to *Telcordia GR-032685°C / 85% r.h. 2000h*

AVAILABLE AS

- ▶ Terminated connector: (E-2000®, Mini AVIM® & DMI) simplex, and E-2000® Backplane 2-6 channels
- ▶ Terminated tubing: available with just 1mm PEEK tubing or additional 2.9mm SS metal jacket

SPECIFICATIONS

CONNECTOR TYPE	WAVELENGTH (nm)	IL (dB) AGAINST REFERENCE		RL AGAINST REFERENCE
		Typ.	Max.	Connected PC 0°
E-2000® PS+	1625 - 1550 - 1310	0.2	0.4	50
DMI PS+***	1625 - 1550 - 1310	0.2	0.4	50
Mini AVIM®***	1625 - 1550 - 1310	0.2	0.4	50
TEST CONDITIONS		IEC 61300-3-4		IEC 61300-3-6 OLCR method / *OCWR method
	VALUE	UNIT	TEST CONDITIONS	
Mating durability	500	mate/demate cycles	IEC 61300-2-2	
Fibre retention (fiber)	5	N	IEC 61300-2-4, 1min, longitudinal	
Fibre torsion (fiber)	0.2	N	IEC 61300-2-5, ±180°, 25 cycles	
Operating temperature	-40/+85**	°C	IEC 61300-2-22	
Storage temperature	-40/+85**	°C	IEC 61300-2-17m -18	

* Measured with high precision reflectometer ** May be further limited by cable specifications ***Specified by similarity

PS+

(Power Solution)

E-2000® PS+, DMI PS+, Mini AVIM® PS+
SINGLE MODE PC

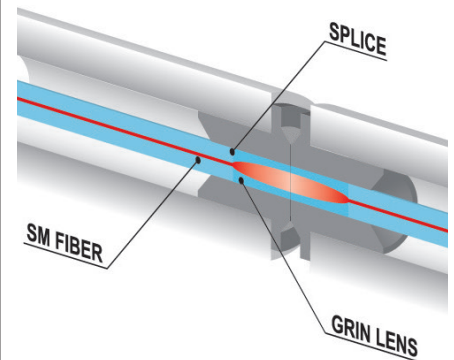

DIAMOND SA | Via dei Patrizi 5 | CH-6616 Losone - Switzerland
Tel. +41 58 307 45 45 | e-mail info@diamond-fo.com

www.diamond-fo.com

Specifications subject to change
without notice

BDD 1951968 06_23

CONNECTOR TYPES AND DIMENSIONS

E-2000® PS+ connectors on 1mm PEEK tubing or 2.9mm metal jacket, 900um - 3mm boot style

Available types: **E-2000® PS+ PC 0°**
 Ferrule material: Zirconia/metal insert
 External parts PC 0°: Plastic (red body and thumb-latch; blue boot)

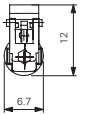
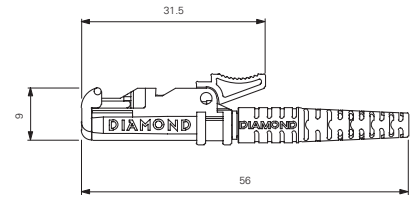

NOTE For color or mechanical keying thumb-latches, please refer to the E-2000® standard datasheet

DMI PS+ connectors on 1mm PEEK tubing, without boot

Available types: **DMI PS+ - PC 0°**
 Ferrule material: Zirconia/metal insert
 External parts: Metal

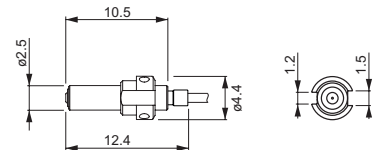

Mounting tool and instructions:

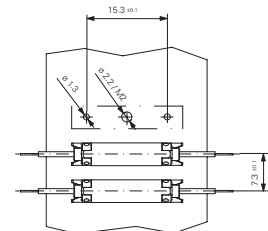
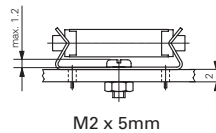
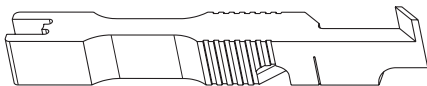

For further information about mounting instructions, please refer to the DMI Part number list

Mini AVIM® PS+ connectors on 1mm PEEK tubing, on 900um boot style

Available types: **Mini AVIM® (PC 0°)**
 Material: According to part list in datasheet "AVIM Family" on page 16

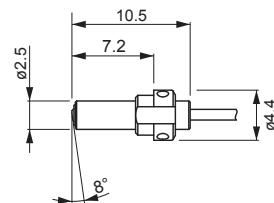
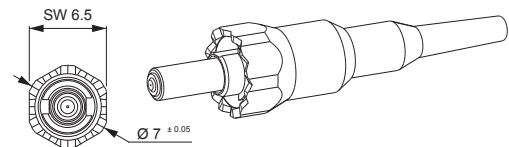
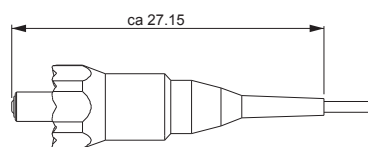

ORDER INFORMATION

Please refer to the part numbers provided in the separate P/N list.

For assemblies or other configurations, please contact your nearest local Diamond representative or fill in the contact form available on the www.diamond-fo.com website.

ADAPTER TYPES AND DIMENSIONS

E-2000® PS mating adapter

Available types: **E-2000®**

External parts PC 0°: Plastic (red body and blue frames)

Mating sleeve: Zirconia

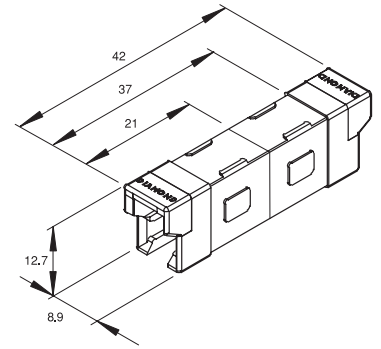

NOTE For complete product descriptions, please refer to the part-specific E-2000® Simplex datasheet.

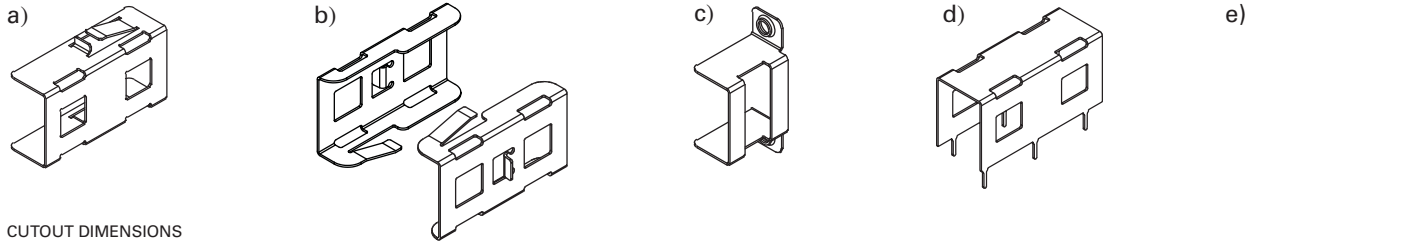

CUTOUT DIMENSIONS

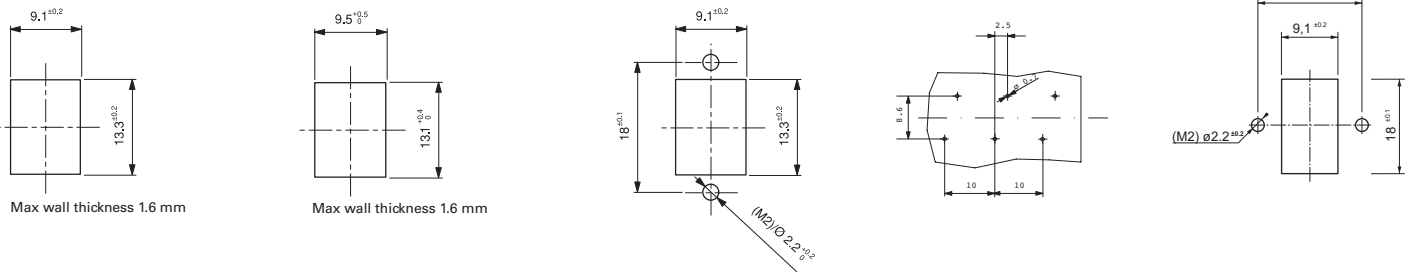

DMI PS mating adapters

External parts: Metal
 Mating sleeve: Zirconia
 Cap colors: Red

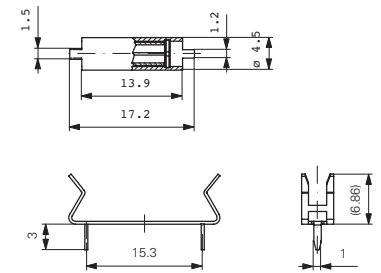

DMI mating adapters clip

External parts: Metal (Cu Be2; tinned solderable)

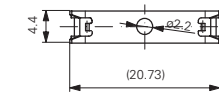

Mini AVIM® mating adapters

Available types: Square flange adapter for wall mount
 Material: According to part list in datasheet "AVIM Family" on page 16

CUTOUT DIMENSIONS

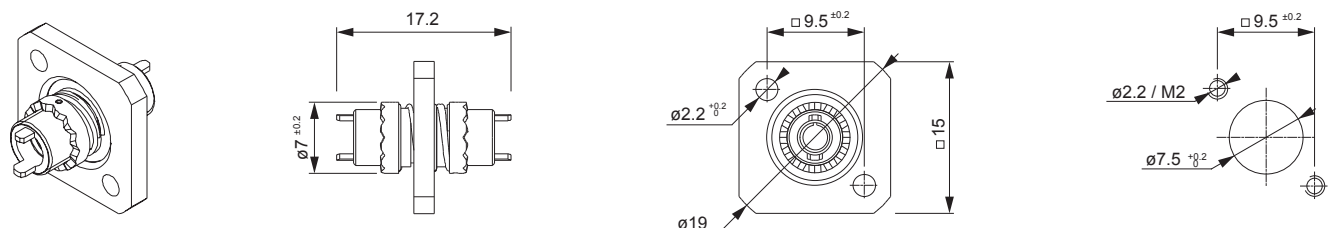

SAFETY INFORMATION FOR POWER SOLUTION CONNECTORS

The Power Solution (PS and PS+) connector utilizes expanded beam technology to reduce the density of the optical power at the interface of the connection. This insures that the connector is less sensitive to contamination and maximum power can be transmitted to the connector without damage.

CLEANING

Cleanliness is a high priority when dealing with high power applications. As such, the basic concept when using PS and PS+ connectors is as follows:

- Before each mating procedure, the connectors must be absolutely clean and inspected with a microscope.
- The ferrule's surface inspection should be performed using an optical microscope with a magnification of at least 200x.
- The connector is normally affected by contamination during handling and mating procedures and the degree of cleanliness of the overall installation is also a critical parameter to be taken into consideration.

HANDLING

Power Solution connectors should be operated only when connected to high power. When unmated, the light source must absolutely be switched off.

SAFETY

Optical connectors are passive components not subjected to Laser safety, but will be when integrated in an active system, such as the output side of a light source.

The following aspects are taken into account when evaluating laser safety requirements:

- The exit beam of these connectors must have a lower Numerical Aperture (NA) as standard connectors in air ($NA=0.026$) or ca. 1.5° divergence. This is used in the calculation of the amount of light that can enter the pupil at 1m.
- The DMI connector does not have a protection cap, therefore, Diamond recommends to putting a protection cap on top with the indication of the laser class according to IEC 60825-1.

The following safety precautions are to be considered as a starting point and each individual is responsible to insure and demand proper safety protocols. The following precautions should not be considered as sufficient and should be re-evaluated from case-to-case.

- Use in a restricted area and allow access only to authorized and qualified personnel.
- Use protective glasses; skin protective measures are also recommended.
- Keep optical behaviour under control: eliminate reflections (also diffuse), close unused optical channels, and avoid light beams at eye level.
- Switch the system on/off with a remote control or interlock and utilize an additional automatic switch off safety system.
- Provide a warning signal when sources are active.
- Provide laser classification markings and danger indications.

Systems that rely upon a minimum required RL level, should use a non-contact PC version with possibly interlock capabilities.